

DURANT

sprl - bvba

PHILIPPEVILLE - BELGIUM

Since 1979

FR / NL



**MATÉRIEL PARCS & JARDINS
PARK EN TUINMACHINES**



**MATÉRIEL FORESTIER
BOSMACHINES**



**EQUIPEMENTS NEIGE
SNEEUWMACHINES**



Sentar
by Univer

**MINI-PELLES
MINIKRANEN NEW !**

DONG FENG

**TRACTEURS HORTICOLES
TUINBOUWTRACTOREN**

Kubota

WWW.SPRLDURANT.BE





sprldurant@sprldurant.be

☎ 071.66.74.92

ENTRETIEN DES ESPACES VERTS

ONDERHOUD VAN GROENE ZONES





TONDEUSES À GAZON
GAZONMAAIER

REF	 mm		 Kw Hp	 Kg.	EJECTION UITWORP
DT 100	0,9m	2	10-20	100	AR + LAT ZIJDE + ACHTER
TC 480	1,20m	3	12-20	166	AR / ACHTER
TC 590	1,50m	3	20-30	198	AR / ACHTER
TC 710	1,80m	3	25-40	244	AR / ACHTER
TC 910	2,35m	5	40-60	286	AR / ACHTER



- 1m20 à 2m35
OPTION : Kit mulching
- 1m20 tot 2m35
OPTIE : Mulching kit

Version quad
Quad versieAvec bac récolteur
Met opvangbakGYROBROYEURS
WEIDEBLOTTERS

REF	 mm	 Kw Hp		 Kg.
DL 10 EV	1m	14-30	2	140
DL 11 EV	1,10m	20-30	2	145
DL 120	1,20m	25-50	2	160
DL 135	1,35m	28-50	2	190
DL 150	1,50m	35-60	2	240
DL 153	1,50m	40-80	3	280
DL 183	1,80m	60-100	3	355
TR 270	2,70m	45-85	6	480

BROYEURS À FLÉAUX QUADS
ATV'S KLEPELMAAIERS

1m20 - 1m50

EPAREUSES
BERMMAAIERS MET HYDR ARM

REF	TÊTE KOP	PORTÉE MAX. MAX VERSTEK	CV PK	KG	KG MIN TRACTEUR MIN KG TREKKER
Micro	60cm	2m	15/20	258	700
M 250	60cm	2,60m	23	290	800
M 300	80cm	3,10m	30	370	900
M 380	80cm	3,90m	35	390	940

COLLECTEUR DE GAZON
GAZON OPVANBAK

530 - 790 1



MICRO







BROYEURS À FLÉAUX KLEPELMAAIERS





CENTURION - TRACTEURS/TREKKERS 20 - 40 CV/PK

Déportable - Verstekbaar



REF				
	mm	Kw Hp	Kg.	
C 106	1,06	20	190	16/32
C 132	1,32	27	230	20/40
C 158	1,58	35	260	24/48



FUNNY ECO - TRACTEURS/TREKKERS 10 - 25 CV/PK

REF				
	mm	Kw Hp	Kg.	
ECO 80	0,80	10	114	24
ECO 93	0,93	12	125	28
ECO 106	1,06	14	132	32
ECO 132	1,32	20	148	40



TL/TM - TRACTEURS/TREKKERS 20 - 70 CV/PK







REF			
	mm	Kg.	
TL 0900	0,97	187	56
TL 1200	1,20	210	72
TL 1500	1,50	220	88
TM 1300	1,30	253	80
TM 1600	1,60	285	96
TM 1900	1,90	310	112







FUNNY TOP - TRACTEURS/TREKKERS 12 - 25 CV/PK

Déport mécanique - Mecanische verstek

REF				
	mm	Kw Hp	Kg.	
T 106	1,06	12	150	32
T 132	1,32	20	165	40







TST - TRACTEURS/TREKKERS 25 - 70 CV/PK

REF					
	mm	mm	Kw Hp	Kg.	
TST 105	1,05	114	25	195	18
TST 120	1,20	132	28	240	20
TST 135	1,35	147	31	280	24
TST 150	1,50	162	34	325	24
TST 165	1,65	177	37	370	28
TST 180	1,80	192	40	415	30
TST 200	2,00	212	45	475	34

FUNNY SUPER - TRACTEURS/TREKKERS 22 - 35 CV/PK

Broyeurs d'accotement - Bermmaaiers

REF				
	mm	Kw Hp	Kg.	
S 106	1,06	22	220	32
S 132	1,32	27	245	40

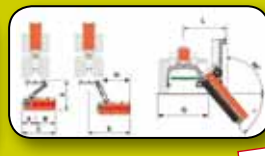

TSA : Broyeurs d'accotement - Bermmaaiers 1m50 - 1m65 - 1m80 - 2m





MUL/MU - TRACTEURS/TREKKERS 30 - 120 CV/PK

IDEAL POUR L'ENTRETIEN
DES BROUSSAILLES
ET DES BOIS

IDEAAL VOOR
HET ONDERHOUD VAN
STRUIKGEWAS EN BOS

- Broyeurs à marteaux pour herbes - broussailles et bois jusqu'à 3 cm pour MUL et 6/7 cm pour MU
- Ouverture de carter arrière réglable (MU)
- Déport mécanique - hydraulique EN OPTION
- Rotor met hammers voor gras - struikgewas en takken tot 3 cm voor MUL en 6/7 cm voor MU
- Regelbare opening van achter carter (MU)
- Mecanische verstek - OPTIE : hydraulisch

TSL - TRACTEURS/TREKKERS 12 - 25 CV/PK

REF				
	mm	Kw Hp	Kg.	
TSL 85	0,85	10	66	28
TSL 95	0,95	12	81	32
TSL 105	1,05	14	96	36
TSL 115	1,15	15	115	40
TSL 125	1,25	16	130	42
TSL 135	1,35	18	145	48

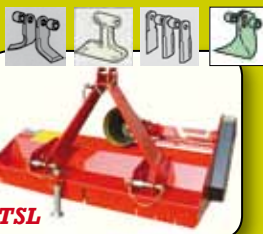

Aussi montage frontal / Ook Frontmontage

OPTIONS :

Couteaux scarificateurs
Marteaux





OPTIES :

Verticuteer messen
Hammers

TONDO - BROYEURS - RAMASSEURS KLEPELMAAIERS MET OPVANG

EXTREME - TRACTEURS/TREKKERS 20 - 50 CV/PK

Vidange en hauteur Uitgieten in het hoogte

REF			BAC OPVANG L		
	mm	Kw Hp		Kg.	
EXT 120	1,20m	20/30	560	270	20
EXT 140	1,40m	25/48	650	315	24
EXT 160	1,60m	30/50	750	360	38



TRM - TRACTEURS/TREKKERS 25 - 50 CV/PK





REF	CM	KG	PALETTES KLEPELS	CV / PK MIN	BAC OPVANG L
TRM 130	130	330	20	25 - 30	0,85 m ³
TRM 150	150	360	24	30 - 40	1 m ³

OPTION : Kit scarificateur OPTIE : Verticuteer kit

FRAISES ROTATIVES GRONDFREZEN







FL - TRACTEURS/TREKKERS 10 - 40 CV/PK

REF				
	mm	Kw Hp	Kg.	
FL 0900	0,9 m	10	149 kg	24
FL 1000	1 m	12	155 kg	24
FL 1100	1,10 m	16	173 kg	24
FL 1200	1,20 m	20	182 kg	30
FL 1300	1,30 m	23	188 kg	30
FL 1400	1,40 m	25	197 kg	36





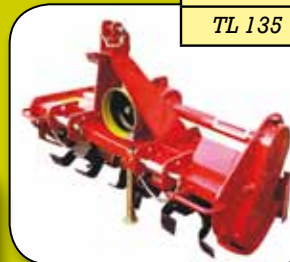

TL - TRACTEURS/TREKKERS 18 - 30 CV/PK

REF				
	mm	Kw Hp	Kg.	
TL 105	1,05 m	18	175 kg	20
TL 120	1,20 m	22	185 kg	24
TL 135	1,35 m	25	195 kg	28







URT - TRACTEURS/TREKKERS 25 - 60 CV/PK



REF				
	mm	Kw Hp	Kg.	
URT 132 ED	1,32 m	25	211 kg	28
URT 150 ED	1,50 m	30	226 kg	32
URT 168 HF	1,68 m	40	252 kg	36
URT 186 HF	1,86 m	50	269 kg	40



FM - TRACTEURS/TREKKERS 30 - 60 CV/PK

REF				
	mm	Kw Hp	Kg.	
FM 1100	1,10 m	30	203 kg	24
FM 1300	1,30 m	35	253 kg	30
FM 1500	1,50 m	40	278 kg	36
FM 1700	1,70 m	50	303 kg	42

CHARRUES PLOEGEN

REF			PROFONDEUR WERKTEDIEPTE
	Kw Hp	Kg.	
DR 10/14/04	10-14	78	15
DR 14/20/03	14-20	85	18
DR 20/24/02A	18-22	92	20
DR 20/30/02B	20-30	129	22
DR 30/01M	30-35	136	25



OPTION : Retournement hydraulique
OPTIE : Hydraulische wentelen



Aussi / Ook :
Charrues 2 socs / 2 scharen ploeg





EXTIRPATEURS EXTIRPATORS

REF				DENTS TANDEN
DT 20	1,20 m	18-26	100 kg	5
DT 25	1,30 m	28-35	115 kg	5
DT 30	1,30 m	28-35	130 kg	5
CMR7	1,75 m	40-55	230 kg	7



SOUS-SOLEUSES DIEPGRONDERS



REF				DENTS TANDEN
DD 1	-	15-18	30 kg	1
DD 3	1,20 m	18-22	75 kg	3
DD 5	1,20 m	24-30	100 kg	5
DD 5R	1,50 m	30-35	110 kg	5
RDL 3	1,40 m	40-50	175 kg	3
RDL 5	1,60 m	45-55	205 kg	5

CULTIVATEURS CULTIVATORS

REF		LIGNES RIJEN	ROULEAU ROL
CUL 110	1,10 m	2	1,20 m
CUL 125	1,25 m	2	1,35 m
CUL 135	1,35 m	3	1,45 m
CUL 155	1,55 m	3	1,65 m



LAMES NIVELEUSES NIVELEERBLAD

REF		LAMES BLAD		
D-120	1,20 m	40 cm	14-30	100
D-140	1,40 m	40 cm	20-40	110
D-160	1,60 m	40 cm	30-50	150

COVER-CROP

- De 0,8 à 2m66
- Van 0,8 tot 2m66
- Pour tracteurs de 20 à 55 CV
- Voor trekkers van 20 tot 55 PK



Aussi / Ook : 2 m / 2,50 m / 3 m

BÊCHEUSES SPITFREZEN

- Pour tracteurs de 16 à 160 CV
- De 0,83 à 3m80
- De 20 à 40 cm de profondeur
- Voor trekkers van 16 tot 160 PK
- Van 0,83 tot 3m80
- Van 20 tot 40 cm dieptewerkte





ACCESSOIRES MOTOCULTEURS MOTOCULTOREN TOEBEHOREN



ENFOUISSEUSES DE PIERRES OVERTOPFREZEN

- Avec rouleau métal déployé + lame niveleuse
- Met rasterrol en niverleerblad

Option : Semoir gazon **Optie :** Gazon zaaimachine

REF	 mm	 Kw Hp	COUTEAUX MESSEN	 Kg.	PROFONDEUR DIEPTEWERKTE
TST 100	1 m	18 cv	28	195	15 cm
TST 115	1,13 m	21 cv	32	218	15 cm





G15



G25



Semoir - Zaaimachine

REF	 mm	 Kw Hp	COUTEAUX MESSEN	 Kg.	PROFONDEUR DIEPTEWERKTE
G15 - 85	85 cm	16	16	270	15 cm
G15 - 105	105 cm	20	20	300	15 cm
G15 - 125	125 cm	25	24	340	15 cm
G25 - 110	110 cm	25	24	440	18 cm
G25 - 130	130 cm	30	28	490	18 cm
G25 - 150	150 cm	40	32	550	18 cm
G25 - 170	170 cm	50	36	610	18 cm

Semoir - Zaaimachine



SEMOIR ENGA 750 ZAAIMACHINE ENGA 750

Aussi : Pour motoculteurs

Ook : Voor motocultoren



- 75 cm - 4 CV - Avancement HST
- 75 cm - 4 PK - HST aandrijving

HERSES ROTATIVES ROTOREGGEN

• Rouleau métal déployé
+ lame niveleuse
sauf Rotex L88



• Rasterrol
+ niveleerblad
behalve Rotex 88



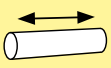

**AUSSI POUR MOTOCULTEURS
OOKVOOR MOTOCULTOREN**

POUR MICRO-TRACTEURS DE 12 À 35 CV

VOOR MICRO-TREKKERS VAN 12 TOT 35 PK

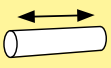
REF					DENTS TANDEN
	mm	cm	Kw Hp	Kg.	
ROTEX L88	88 cm	103 cm	12-30	188	10
ROTEX L104	104 cm	119 cm	14-30	241	12
ROTEX L120	120 cm	135 cm	18-30	294	14
ROTEX L136	136 cm	151 cm	23-30	333	16

REF					DENTS TANDEN
	mm	cm	Kw Hp	Kg.	
D 100	90 cm	100 cm	14-18	150	10
D 120	105 cm	120 cm	18-25	180	12
D 135	122 cm	135 cm	20-30	250	14
D 150	140 cm	150 cm	25-30	250	16
D 170	155 cm	170 cm	30-35	280	18



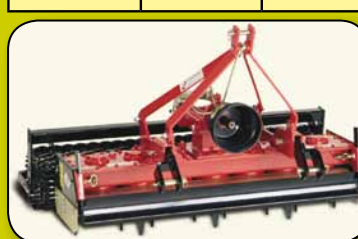

Semoir - Zaaimachine



Semoir
Zaaimachine



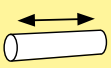

POUR TRACTEURS HORTICOLES DE 20 À 70 CV

VOOR TUINBOUWTREKKERS VAN 20 TOT 70 PK

REF					DENTS TANDEN
	mm	cm	Kw Hp	Kg.	
ROTEX 110	110 cm	123 cm	25-45	287 kg	10
ROTEX 130	130 cm	143 cm	30-45	312 kg	12
ROTEX 150	150 cm	163 cm	35-50	347 kg	14
ROTEX 170	170 cm	183 cm	40-70	398 kg	16
ROTEX 190	190 cm	203 cm	50-70	453 kg	18

• Rouleau métal déployé
Lame niveleuse

• Rasterrol - Niveleerblad

REF					DENTS TANDEN
	mm	cm	Kw Hp	Kg.	
F 61-90	90 cm	20-25	250 kg	8	
F 61-110	110 cm	25-30	250 kg	10	
F 61-130	130 cm	30-35	310 kg	12	
F 61-150	150 cm	35-40	340 kg	14	
F 61-150	170 cm	40-45	380 kg	16	
F 61-190	190 cm	45-50	420 kg	18	
F 61-210	210 cm	50-65	460 kg	20	



Semoir
Zaaimachine



Option :
Semoir électrique

Optie :
Elektrische zaaimachine

SEMOIRS MARAICHERS GROETEN ZAAMACHINES

- Petites et grosses graines
- Semis en pleine terre ou en serre
- Kleine en grotere zaden
- Op veld of in tuinkassen / serres zaaien



A POUSSER
GEDUWDE



AUTOTRACTÉS
WIELAANDRIJVING



POUR MOTOCULTEURS
VOOR MOTOCULTOREN



POUR TRACTEURS
VOOR TRACTOREN

TONDEUSES INTERCEPTS KANTENMAAIERS

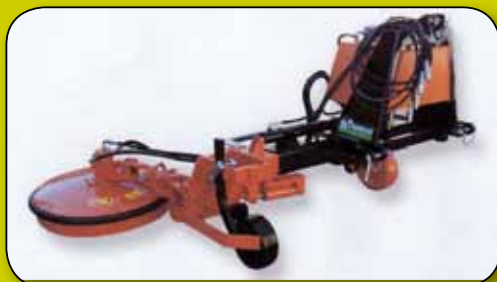

BETONNIERES BETONMOLEN



- 3-points - 3-punt
- 180 / 350 / 430 l.

KIVA
LA FORCE NATURE

Grillo
AGRIGARDEN MACHINES



TONDEUSES DEBROUSSILLEUSES
RUWTERREINMAAIERS



SCARIFICATEURS
VERTICUTEERMACHINES



MOTOFACHEUSES
MAAIBALKEN



MOTOCULTEURS
MOTOCULTOREN



BROYEURS DE VEGETAUX
HOUTHAKSELAARS

CROSSJET



TONDEUSE DEBROUSSILLEUSE
RUWTERREINMAAIER
92 CM - 20 CV/PK - HST



TRANSPORTEURS A CHENILLES
MINI-TRANSPORTERS

TARIÈRES GRONDBOREN

TAEV MICRO-TRACTEURS

TAEV MICRO-TREKKERS

- Max 25 CV
- Livrée avec 2 vrilles : Ø 150 / Ø 220
- Longueur 85 cm
- Max 25 PK
- Geleverd met 2 boren : Ø 150 / Ø 220
- 85 cm lengte



THERMIQUE

BENZINE



- Moteur 2 temps 49 CC
- Livrée avec 3 vrilles : Ø 100 / Ø 150 / Ø 200
- 2-tak motor 49 CC
- Geleverd met 3 boren : Ø 100 / Ø 150 / Ø 200

TRACTEURS HORTICOLES / AGRICOLES

TUINBOUW / LANDBOUWTREKKERS

- Pour tracteurs de 25 à 70 CV
- Vrilles : Ø 100 à 600 mm - Longueur 1m
- Voor trekkers van 25 tot 70 PK
- Boren : Ø 100 tot 600 mm - 1m lengte



REF	Vrilles Boren Ø	 Kw Hp	 Kg.
TA/1	100-400	25-50	135 kg
TA/2	100-600	25-70	165 kg



POUR MINI-PELLES

VOOR MINIKRANEN



Aussi : modèles lourds
Ook : zware modellen



ROULEAUX LANDROLLEN



**POUR MOTOCULTEURS
VOOR MOTOCULTOREN**



Version 3-points - 3-punt versie

Aussi :
Pour motoculteurs - Ø 28 cm
2 x 45 cm + 1 x 55 cm

Ook :
Voor motocultoren - Ø 28 cm
2 x 45 cm + 1 x 55 cm



**Version 3-points / Trainé
3-punt / Getrokken versie**

- De 1m20 à 2m50
- Ø 32 et 60 cm
- Lestable avec de l'eau

Option : Timon

- Van 1m20 tot 2m50
- Ø 32 en 60 cm
- Vulbaar met water

Optie : Trekarm

DÉSHERBEURS THERMIQUES ONKRUIDBRANDERS

Utilisation privée / Particulier gebruik

1099 B1



- 1 brûleur + tuyau 4 m
- 1 brander + 4 m darm

PRO PACK A



- 1 brûleur + tuyau 4 m + chariot
- 1 brander + 4 m darm + karretje

PRO PACK B



- 1 brûleur + tuyau 4 m + chariot / sac à dos
- 1 brander + 4 m darm + karretje / rugzak

PRO R4



- 4 brûleurs + tuyau 4 m + chariot + sac à dos
- 4 branders + 4 m darm + karretje + rugzak

Utilisation pro / Pro gebruik



Avec ou sans rampe de brûleurs
Met of zonder brandersraam

Sur support
Op steun



3-points
3-punt

NEW

500 / 1000 l

DÉSHERBEURS EAU CHAUDE THERMISCHE STOOMONKRUIDBESTRIJDERS



BROSSE DE DÉSHÉRBAGE MÉCANIQUE BORSTEL VOOR MECANISCHE WEEDING



PULVÉRISATEURS SPUITMACHINES

ACTIS

Pulvérisateurs portés de 100 à 1000 l
3-punt gedragen sproeiers
van 100 tot 1000 l



Caractéristiques techniques :

- Rampe 2 à 12 m
- Enrouleur 25/50 m
- Polyvalence avec la pompe PM75 :
Pulvérisation et Arrosage

Technische gegevens :

- Suijtbomen van 2 tot 12 m
- Oprollers 25/50 m
- Veelzijdigheid met PM75 pomp :
Sproeien en water besproeiing



EVOLIS

Pulvérisateurs pour quads 50 et 80 l
Quads sproeiers 50 en 80 l



- 12 V 8 A - 8l/min - 3 bar
- Rampes 2 et 4 m
- Lance + 5 m de tuyau
- 12 V 8 A - 8l/min - 3 bar
- Suijtbomen 2 en 4 m
- Suijtlans + 5 m darm



VISION

Pulvérisateurs pour tracteurs
tondeuses
Suijtmachines voor zitmaaiers



Caractéristiques techniques :

- 12 V - 8l/min - 3 bar
- 50 et 75 l
- Rampe de 2 m
- 5 m de tuyau + lance

Technische gegevens :

- 12 V - 8l/min - 3 bar
- 50 en 75 l
- Suijtboom van 2 m
- 5 m darm + suijslans

POLYPUL

Pulvérisateurs horticoles
Tuinbouw sproeitoestellen



Caractéristiques techniques :

- 50 à 200 l
- Moteur thermique ou électrique
- Rampes de 2, 3 et 4 m
- Enrouleurs 25 et 50 m

Technische gegevens :

- 50 tot 200 l
- Benzine of elektrische motor
- Suijtbomen van 2, 3 en 4 m
- Oprollers 25 en 50 m



ELIS

Pulvérisateurs pour véhicules SSV
Suijtmachines voor SSV voertuigen

Caractéristiques techniques : **Technische gegevens :**

- 200, 300 et 400 l
- Pulvérisation et arrosage
- Rampes 2, 3 et 4 m
- Enrouleurs 25 et 50 m

- 200, 300 en 400 l
- Sproeien en water besproeiing
- Suijtbomen van 2, 3 en 4 m
- Oprollers van 25 en 50 m



PULVERISATEURS ECO ECO SPUITMACHINES

Sentar
by Univert

A DOS / RUGSPROEIER

- 20 l - Moteur Honda 4 temps
- 20 l - Honda motor 4-takt



PORTÉ 3-POINTS

3-PUNT GEDRAGEN

- 120 / 200 / 300 / 400 l
- Rampe de 3 ou 4 ou 7 m
- Tuyau et lance

Option : enrouleur

- 120 / 200 / 300 / 400 l
- Smitboom van 3 of 4 of 7 m
- Darm en lans

Optie : oproller



POUR TRACTEURS DE JARDIN

VOOR ZITMAAIERS

- 50 / 100 l
- Rampe 2 m
- 5 m de tuyau + lance
- 50 / 100 l
- Smitboom 2 m
- 5 m darm + lans



POUR VOOR QUADS

- 70 l
- Rampe de 3 m
- 5 m de tuyau + lance
- 70 l
- Smitboom 3 m
- 5 m darm + lans



BROUETTE DE PULVÉRISATION

TUINBOUW SPROEITOEESTEL

- 120 l - Moteur Honda 4 CV - 25 l/min
- 30 BAR - Enrouleur + 25 m de tuyau + lance
- 120 l - Honda motor 4 PK - 25 l/min
- 30 BAR - Oproller + 25 m darm + lans



ASPIRATEURS DE FEUILLES BLADENZUIGERS

SUR RIDELLES

VOOR SCHOTTEN



- Turbine Ø 350 ou 400
- Moteurs 9 à 16 CV
- Turbine Ø 350 ou 400
- Motor 9 à 16 PK

SUR REMORQUES

OP AANHANGWAGENS



- Turbine Ø 400 ou 500
- Moteurs 13 à 20 CV
- Turbine Ø 400 ou 500
- Motor 13 à 20 PK

3-POINTS TRACTEURS

VOOR TREKKERS



- Turbine Ø 400
- Min. 13 CV
- Cardan
- Turbine Ø 400
- Min. 13 PK
- Cardan

NEW

SPIDAIR SP 256



PROMO

- Adaptable sur ridelles remorques
- Turbine Ø 400 mm
- Sécurité entre moteur et turbine
- Tuyau d'aspiration de 3m30 (Ø 160 mm)
- Moteur B&S 6,5 CV - 70 kg
- Aanpasbaar op schotten van aanhangwagens
- Turbine Ø 400 mm
- Veiligheid tussen motor en turbine
- 3m30 zuigbuis (Ø 160 mm)
- B&S 6,5 PK - 70 kg

**MATÉRIEL PDT
AARDAPPELEN MACHINES**

**PLANTEUSES PDT
AARDAPPELPLANTERS**

POUR MICRO-TRACTEURS ET MOTOCULTEURS

VOOR MICRO-TREKKERS EN MOTOCULTOREN



- 1, 2 ou 3 rangs
- Automatique
- Disques butteurs
- 1, 2 of 3 rijen
- Automatisch
- Achter schijven

NEW



*Semi automatique
Half-automatisch*

POUR TRACTEURS HORTICOLES ET AGRICOLES

VOOR TUINBOUW EN LANDBOUW TREKKERS



*Automatique
Automatisch*

- 2 et 4 rangs
- 2 en 4 rijen



**BUTTEURS PDT
OPHOGERS**

POUR MICRO-TRACTEURS

VOOR MICRO-TREKKERS



*Butteurs
Ophogers
(maxi 3)*



*+
Arracheurs PDT
Aardappelrooiers
(maxi 3)*



*+
Vibroculteurs
Vibrocultors
(maxi 3)*

**ARRACHEUSES PDT
AARDAPPELROOIERS**

POUR MICRO-TRACTEURS

VOOR MICRO-TREKKERS

48 cm - Ejection arrière / 48 cm - Achteruitworp
Maxi 27 CV/PK



POUR TRACTEURS HORTICOLES ET AGRICOLES

VOOR TUINBOUW EN LANDBOUW TREKKERS

- 2m - 3 éléments
- 2 m - 3 elementen





- 1 rang - Ejection latérale
- 1 rij - Zijdeuitworp
- A partir de / Vanaf :
30 CV/PK

MATÉRIEL DE FENAISSON HOOIMACHINES

MONTAGE ARRIÈRE - FRONTAL - LATÉRAL

ACHTER - FRONT - ZEIDELINGS KOPPELING

**POUR MICRO-TRACTEURS
VOOR MINI-TREKKERS**

TYPE		COUTEAUX MESSEN			MONTAGE
	mm		Kw Hp	Kg.	
TFU 800	0,8 m	4	10-11	85	AR / ACHTER
TFU 1000	1 m	4	14-18	90	AR / ACHTER
TFU 1150	1,15 m	8	16-20	95	AR / ACHTER
D 100	1 m	4	15-25	175	LAT / ZIJDE
D 115	1,15 m	8	18-30	190	LAT / ZIJDE
D 135	1,35 m	8	22-35	205	LAT / ZIJDE

FAUCHEUSES À TAMBOURS TROMMELMAAIERS



TFU





D





Z

**POUR TRACTEURS HORTICOLES / AGRICOLES
VOOR TUINBOUW / LANDBOUWTREKKERS**

TYPE				MONTAGE
	mm	Kw Hp	Kg.	
Z064/3	1,35 m	20	265	LAT / ZIJDE
Z064	1,35 m	25	345	LAT / ZIJDE
Z010	1,65 m	40	415	LAT / ZIJDE
Z010/1	1,85 m	60	460	LAT / ZIJDE
Z010/2	2,12 m	70	580	LAT / ZIJDE

BARRES FAUCHEUSES VINGERBALKE





REF			
	mm	Kw Hp	Kg.
DF 135	135	12	188 kg
DF 150	150	12	200 kg

**AUSSI DE 1,80 M À 2,70 M
OOK VAN 1,80 M TOT 2,70 M**

FAUCHEUSES À DISQUES SCHIJVENMAAIERS



**AUSSI DE 1,65 M À 3,20 M
OOK VAN 1,65 M TOT 3,20 M**

REF			
	mm	Kw Hp	Kg.
DLN 3D	120	20	230 kg

RATEAUX - FANEURS SNELHOOIERS



- 1m20 à 2m50
- 1m20 tot 2m50
- Faner et andainer avec une seule machine
- Hooikeerder + hark met een machine



COMBI





FANEUSES HOOIKEERDERS

TYPE		BRAS ARMEN		
	mm		Kw Hp	Kg.
DT 200	2 m	5	14	120 kg
DT 200 C COMBI	2 m	5	14	160 kg
DT 240	2,40 m	6	16	130 kg
DT 260	2,60 m	6	20	140 kg
DT 260 C COMBI	2,60 m	6	20	180 kg
DT 310	3,10 m	5	25	170 kg

DT 200 C et DT 260 C = Faneuse + andaineuse
DT 200 C et DT 260 C = Hooikeerder + hark

ANDAINEURS CIRKELHARKEN

REF	 mm	TRANSPORT VERVOER	 Kw Hp	 Kg.
DG 200	2 m	1,30 m	16	200 kg
DG 240	2,40 m	1,10 m	20	240 kg
DG 280	2,60 m	1,20 m	25	265 kg



ENRUBANNEUSES INPAKKERS

- Pour tracteurs à partir de 15 CV
- Pour balles rondes et carrées (2 modèles)
- Voor trekkers vanaf 15 PK
- Voor ronde en vierkante balen (2 modellen)



MINI-PRESSES ROTO-PERS



- Pour tracteurs à partir de 16 CV
- Balles rondes D 570x630 mm +/- 15 à 30 kg
- Voor trekkers vanaf 16 PK
- Ronde balen D 570x630 mm +/- 15 tot 30 kg

SEMOIRS QUADS QUADS STROOIERS

NEW





- Anti limaces, engrais, semences, ...
- Anti-slakken, meststof, zaad, ...



COMBI : presse + enrubanneuse
COMBI : pers + inpakker

DISTRIBUTEURS D'ENGRAIS MESTSTOFSTROOIERS

REF	 mm	 Kg.	LARGEUR TRAVAIL WERKTEBREEDTE	POIDS EIGENGEWICHT
XA 150	150	550	6/18 m maxi	45 kg
XA 300	250	550	6/18 m maxi	49 kg
XA 500	350	550	6/18 m maxi	54 kg



- Cuve acier
Option : Cuve résine
- Réglage du débit
- Pour engrais / sel / sable
- Ijzer vat
Optie : Polyethyleen vat
- Regelen van debiet
- Voor meststof / zout / zand

Option - Optie : Kit sel - Zout kit

VERSION TRACTÉE / GETROKKEN VERSIE : 100 - 250 - 350 l



EQUIPEMENTS MANÈGE MANEGE TOEBEHOREN

EBOUSEURS DE PRAIRIES WEIDESLEPEN

AÉRATEURS DE PRAIRIES WEIDEBELUCHTERS

REF	
D 2A 120	1,20 m
D 2A 150	1,50 m
D 2A 180	1,80 m
D 2A 210	2,10 m
D 2A 240	2,40 m

Options :

- 2 rangées de palettes
- 2 extensions de 30 cm

Opties :

- 2 rijen bladen
- 2 verlengstukken van 30 cm

- Galvanisée
- 1 rangée de palettes ébouseuses de 30 cm + 2 rangées de dents flexibles scarifiantes et aératrices
- Verzinkt
- 1 rij 30 cm bladen + 2 rijen veertanden



REF		LARGEUR TRANSPORT VERVOERBREEDETE
D 140	1,40 m	1,40 m
D 170	1,70 m	1,70 m
D 200	2 m	2 m
D 260	2,60 m	1,20 m
D 400	4 m	2 m

EGALISATEURS DE MANÈGES MANEGEVLAKKERS

ECO 1m20 - 1m50 - 1m80 - 2m



PRO

- 1m20 - 1m50 - 2m - 2m25 - 2m50
- Châssis niveleur - Rangées de dents + rouleau à pression réglable
- Tête d'attelage articulée
- Patins de glissement
- Aussi pour les pistes en géotextile
- Verstelbare triltanden en eggetanden + regelbare aandrukrol
- Meedraaiende aanpik
- Glijshotels met afgeronde hoeken
- Ook voor geotextiele pisten



POMPE À EAU



WATERPOMP

- Débit +/- 110 l/min
- +/- 110 l/min debiet

ASPIRATEUR POUR BOXES DE CHEVAUX ZUIGMACHINE VOOR PAARDEN SCHUREN



BALAYEUSES VEEGMACHINES

- 1,20m - Balai Ø 550 mm - 110 kg
- Orientation fixe 20° à droite ou réglable
- Entraînement : hydraulique tracteur ou prise de force
- 1,20m - Borstel Ø 550 mm - 110 kg
- Hydraulische aandrijving of aftakas



- 1m50 - 1m70 - 2m25 - 2m70
- Bac de ramassage
- Montage avant ou arrière
- 2 roues - Balais Ø 580 mm
- 1m50 - 1m70 - 2m25 - 2m70
- Opvangbak
- Front of achter koppeling
- 2 steunwielen - Borstel Ø 580 mm



Horticultuurbouw

- 1m - Balai Ø 280 mm - 120 kg
- Bac de ramassage de 150 l
- Entraînement robuste par les roues
- 1m - Borstel Ø 280 mm - 120 kg
- Opvangbak van 150 l
- Getrokken versie



Quad

TAILLE-HAIES HAAGSCHAREN

POUR MICRO-TRACTEURS ET TRACTEURS DE JARDIN

VOOR MICRO-TREKKERS EN ZITMAAIERS

VERSION PRO PRO-VERSIE GALAX



UTILISATION PRIVÉE / PARTICULIER GEBRUIK



MTP pour MICRO-TRACTEURS

- Portée max. verticale : 3 m ou 3 m 50*
- Portée max. horizontale : 2 m 50 ou 3 m*
- Système de coupe : 2 lames oscillantes de 90 cm
- Pompe hydraulique indépendante + réservoir + distributeur
- Poids : 70 kg à 80 kg

MTP voor MICRO-TREKKERS

- Max verticale hoogte : 3 m of 3 m 50*
- Max horizontale hoogte : 2 m 50 of 3 m*
- 90 cm dubbelwerkende messen
- Onafhankelijke pomp + tank + bediening
- Eigen gewicht : 70 kg tot 80 kg

MPP pour TRACTEURS DE JARDIN

- IDEM avec moto
- pompe de 5,5 CV
- et réservoir
- Poids : +/- 75 kg

* En option / Optie

MPP voor ZITMAAIERS

- IDEM met benzine motor van 5,5 PK
- Eigen gewicht : +/- 75 kg

BRM 120

- Pour tracteurs min 16 CV / 500 kg
- Lame 1m20 (max 3 cm)
- Montage arrière ou frontal

- Voor trekkers min 16 PK / 500 kg
- Kop van 1m20 (max 3 cm)
- Front of achter koppeling

VERSION SEMI-PRO SEMI-PRO VERSIE BRM

NEW

BRM 150

- Pour tracteurs min 27 CV / 700 kg
- Lame 1m50 (max 3 cm) - *En option: 2m*
- Montage arrière ou frontal
- Châssis réversible innovateur qui assure une coupe sur les 2 côtés du tracteur

- Voor trekkers min 27 PK / 700 kg
- Kop van 1m50 (max 3 cm) - *Optie: 2m*
- Front of achter koppeling
- Werkt op linkse en rechtse kant van trekker

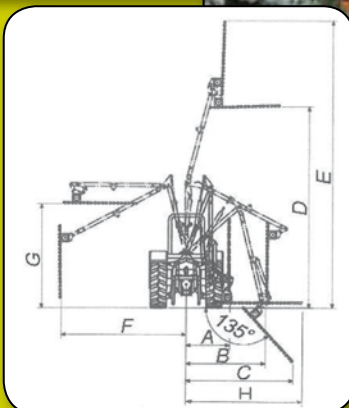

	BRM 120	BRM 150
A mm	1000	900
B mm	1400	1800
C mm	1700	2000
D mm	2600	3700
E mm	4100	5000
F mm	-	2850
G mm	-	1800
H mm	2050	2450

OPTIONS : Pompe indépendante
Echangeur de chaleur
Commande électrique

OPTIES : Onafhankelijke pomp
Oliekoeler
Electro-hydraulische bediening

Tête taille-haies 1m20, 1m50 et 2m
pour bras débroussaillieurs

Haagschaar kop 1m20, 1m50 et 2 m
voor hydraulische armen

BENNETTES TRANSPORTBAKKEN

- Pour tracteurs horticoles (EV) et agricoles (AG)
- Porte arrière - Lame racloir
- Voor tuinbouw (EV) en landbouw (AG) trekkers
- Met klep en achter schraper

REF	TYPE	LARGEUR BREEDTE	PROFONDEUR DIEPTE	HAUTEUR HOOGTE	POIDS EIGEN GEWICHT
10 SAR	EV	1m	0,65m	0,45m	56 kg
12 SAR	EV	1,20 m	0,65m	0,45m	60 kg
10 R	EV	1m	0,65m	0,55m	90 kg
12 R	EV	1,20m	0,65m	0,55m	100 kg
14 R	EV/AG	1,40m	0,93m	0,60m	125 kg
16 R	AG	1,60m	0,93m	0,60m	140 kg
18 R	AG	1,80m	0,93m	0,60m	155 kg
18 SAR	AG	1,80m	0,93m	0,60m	190 kg
20 SAR 4	AG	2m	0,93m	0,60m	270 kg

R : Bennage bras de relevage / Front kiepend

SAR : Bennage central / Middel kiepend



GODETS HYDRAULIQUES HYDRAULISCHE SCHEPBAKKEN

- Pour micro-tracteurs
- Voor micro-trekkers

REF	LARGEUR BREEDTE	L	POIDS EIGENGEWICHT
12 SAR V	1,20m	180 l	92 kg
14 SAR V	1,40m	210 l	97 kg



- Pour tracteurs agricoles
- Voor Landbouwtrekkers
- 1m80 - 2m - 2m20 - 2m40



PICS À BALLES BALENDRAGERS



- Pour tracteurs agricoles et horticoles
- 3-points ou pour chargeurs
- Voor landbouw en tuinbouw trekkers
- 3-punt koppeling of voor frontladers

FOURCHES À PALETTES PALLETVORKEN

REF	LONGUEUR FOUCHES VORKEN LENGTE	CU LAADVERMOGEN
FD 500	0,75m	300 kg
FD 750	0,75m	750 kg
DD 1000 R	0,78m	750 kg
DD 1200	1m	1,2 T



FD 500 : Micro-tracteurs / Micro-trekkers

DD 1000 R : Fourches réglables / Verstelbare vorken

MATS ÉLÉVATEURS HEFTMAST

- 0,8 T - 1,5 T - 2 T
- Duplex - Triplex



NEW

COMBINÉ PORTE PALETTES / PIC BALLES COMBI PALLETVORK / BALENDRAGER

- CU : 300 kg
- Fourches / pics réglables de 70 cm
- Laadvermogen : 300 kg
- Verstelbare vorken / pinnen van 70 cm



TONNE À EAU WATERTANK



• 1100 l

EPANDEUR À FUMIER MESTWAGEN

- 1,5 T - 2m x 1m x 0,75m
- Moulins horizontaux
- Horizontale molen



REMORQUES À RIDELLES KIPWAGENS



**HOMOLOGATION ROUTE
WEG GEKEURD**



POUR MOTOCULTEURS

VOOR MOTOCULTOREN

TYPE	KG	DIMENSIONS AFMETINGEN	RIDELLES SCHOTTEN	ROUES WIELEN
14	500	1,30 x 1,00	0,30	400x8 4 plis
15	600	1,30 x 1,00	0,30	450x10
16	800	1,60 x 1,10	0,35	145x13 RECH

POUR QUADS

VOOR ATV'S

TYPE	Kg	DIMENSIONS AFMETINGEN	RIDELLES SCHOTTEN	ROUES WIELEN
QR18	400	1,30 x 1,00	0,30	18x9,50-8
QR19	600	1,60 x 1,00	0,35	21x9-10
QR20	700	2,00 x 1,20	0,35	21x9-10



POUR TRACTEURS

VOOR TREKKERS

TYPE	Kg	Dimensions Afmetingen	Ridelles Schotten	Roues Wielen
22	1000	2,00x1,20	0,35	155x13 RECH
23	1000	2,00x1,20	0,35	155x13 RECH



TYPE	KG	DIMENSIONS AFMETINGEN	RIDELLES SCHOTTEN	ROUES WIELEN
GV 31 BR	3000	3,00x1,50	0,50	10 0-15 8 plis
GV 40 BRC	4000	3,20x1,80	0,50	10 0-5 12 plis
GV 46 BRCC	4600	3,50x1,98	0,50	11 5-15 12 plis
GV 60 BR	6000	4,00x1,98	0,50	13-065-18



MODÈLES GV HOMOLOGUÉS ROUTE

GV MODELEN GEKEURD VOOR HET VERKEER

VERSION TRIBENNE

3 ZIJDIGKIPPEND

TYPE	Kg	DIMENSIONS AFMETINGEN	RIDELLES SCHOTTEN	ROUES WIELEN
GV 31 TRI	3000	3,00x1,50	0,50	10 0-15 8 plis
GV 46 TRI	4600	3,50x1,98	0,50	11 5-15
GV 50 TRI	5500	3,50x1,98	0,50	12 5-15



RT 700



RT 1000/1000H



RT 2



RT 2

TYPE	Kg	DIMENSIONS AFMETINGEN	RIDELLES SCHOTTEN	BENNAGE KIPPEND	ROUES WIELEN
RT 700	700	123 x 95	30 cm	Méc.	16 x 6 x 6,5
RT 1000	1000	194 x 115	35 cm	Méc.	145/70R13
RT 1000 H	1000	194 x 115	35 cm	Hydr.	145/70R13
RT 2	2500	244 x 145	37 cm	Hydr.	10.0/75-15.3

OPTION :

Rehausses grillagées

OPTIE :

Opbouw betonnet



RT 2 Homologuée route avec frein hydraulique
RT 2 Goed gekeurd voor het verkeer met hydraulische remmen

Photos non contractuelles. Toutes les données techniques sont révisables et données à titre purement indicatif. Alle gegevens mogen veranderen. Neemt contact met ons voor meer inlichtingen.

**CHARGEURS
FRONTLADERS**



POUR / VOOR :

**KUBOTA-ISEKI-JD-SHIBAURA-YANMAR-NEWHOLLAND
LANDINI-LAMBORGHINI-SAME-DEUTZ-MF-GOLDONI
FERRARI-VALPANADA - MAC CORMICK - PASQUALI - BCS
ANTONIO CARRARO - KIOTI - ...**





AUSSI POUR MICRO-TRACTEURS D'IMPORTATION

OOK VOOR IMPORT MICRO-TREKKERS

**EXCAVATRICES
RETRO-GRAAF MACHINES**



TYPE	 Kg.	GODET BAK	 Kw Hp	PROF. DIEPTEWERKTE
A15	300kg	25cm	16/30	1,55 m
A18	350kg	30cm	22/35	1,80 m
A22	400kg	30cm	30/50	2,20 m
A24	550kg	30/40cm	40/80	2,40 m
A26	650kg	40cm	50/100	2,60 m

	A15	A18	A22	A24	A26
A mm	1150	1300	1610	1970	2060
B mm	1850	2150	2500	3010	3030
C mm	1550	1880	2150	2400	2575
D mm	2020	2450	2650	3150	3280

**Accessoires :
Toebehoren :**



TYPE	 Kg.	GODET BAK	 Kw Hp	PROF. DIEPTEWERKTE
AG10	220 kg	25 cm	12/35	1,40 m
AG15	340 kg	25 cm	20/40	1,40 m
AG30	405 kg	35 cm	25/60	1,80 m

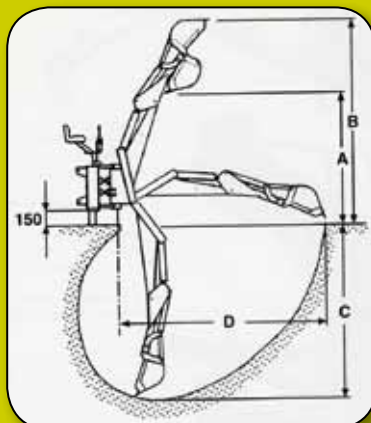

TREUILS FORESTIERS BOSLIEREN

MÉCANIQUES 3 À 7 T

MECANISCH 3 TOT 7 T

REF	PUISSANCE KRACHT	CÂBLE KABEL	 Kg.	LARGEUR BREEDTE	VITESSE SNELHEID
BK300	3 T	70mØ8mm	181	1,01 m	0,9 m/s
BK350	3,5 T	70mØ8mm	224	1,21 m	0,9 m/s
BK400	4 T	70mØ9mm	304	1,42 m	0,9 m/s
BK500	5 T	70mØ10mm	324	1,52 m	0,9 m/s
BK500 R	5 T	70mØ10mm	344	1,52 m	0,6 m/s
BK700 R	7 T	80mØ12mm	540	1,62 m	0,6 m/s



MATÉRIEL FORESTIER

BOS MACHINES

ÉLECTRO-HYDRAULIQUES 5 À 9 T

ELEKTRO-HYDRAULISCH 5 TOT 9 T

avec télécommande au bout de 5 m de câble électrique
met afstandsbediening met 5 m elektrische kabel

REF	PUISSANCE KRACHT	CÂBLE KABEL	 Kg.	LARGEUR BREEDTE	VITESSE SNELHEID
BK500 EH	5 T	70mØ10mm	344	1,52 m	0,6 m/s
BK750 EH	7 T	80mØ11mm	540	1,62 m	0,6 m/s
BK910 EH	9 T	100mØ12mm	641	1,82 m	0,6 m/s
BK750 EHP	7 T	100mØ12mm	770	1,82 m	0,6 m/s
BK910 EHP	9 T	100mØ13mm	840	2,02 m	0,6 m/s



TREUIL FRONTAL / FRONT BOSLIER BK500 EHF

- 5 T - Electro-Hydr
- 70 m câble Ø 10 mm
- 1m52 - 425 kg
- 5 T - Elektro-Hydr
- 70 m kabel Ø 10 mm
- 1m52 - 425 kg



Accessoires :
Toebehoren :



OPTION :
Radio-commande
OPTIE :
Afstandsbediening



NOUVEAUTÉS NIEUWIGHEID

- Dérouleur hydraulique du câble pour EH
- Hydraulische afrollen van kabel voor EH



PINCES À BOIS HOUTGRIJERS



OPTION / OPTIE :
Rotator

TREUIL POUR TRONÇONNEUSES BOSLIERVOOR MOTORZAGEN



- 1 T - 80 m câble Ø 6 mm
- Vitesse du câble : 0,5 m/s
- Pour tronçonneuses de 3 à 4,8 KW
- 1 T - 80 m kabel Ø 6 mm
- Kabel snelheid : 0,5 m/s
- Voor motorzagen van 3 tot 4,8 KW

BROYEURS DE BRANCHES HOUTHAKSELAARS



POUR TRACTEURS

VOOR TREKKERS

CIP
Production de plaquettes pour chauffage ou paillage
Versnipperde materiaal voor verwarming of voor bloemperken
CIP 800

- 8 cm
- A partir de/vanaf 14 CV/PK

CIP 1000
CIP 1100

- 10 cm
- A partir de/vanaf 20 CV/PK

CIP 1200

- 12 cm
- 1 rouleau entraîneur
1 invoerrol
- Pompe indépendante
Onafhankelijke pomp
- A partir de/Vanaf 25 CV/PK

CIP 1300

- 13 cm
- 2 rouleaux entraîneurs
2 invoerrollen
- Pompe indépendante
Onafhankelijke pomp
- No-stress
- A partir de/vanaf 25 CV/PK

CIP 1500

- 15 cm
- 2 rouleaux entraîneurs
2 invoerrollen
- Pompe indépendante
Onafhankelijke pomp
- No-stress
- A partir de/vanaf 40 CV/PK

CIP 2200 FOREST

- 22 cm
- 2 rouleaux entraîneurs
2 invoerrollen
- No-stress
- A partir de/vanaf 80 CV/PK

CIP 2200

- 22 cm
- 2 rouleaux entraîneurs
2 invoerrollen
- Pompe indépendante
Onafhankelijke pomp
- No-stress
- A partir de/vanaf 80 CV/PK

CIP 3200

- 32 cm
- 2 rouleaux entraîneurs
2 invoerrollen
- Pompe indépendante
Onafhankelijke pomp
- No-stress
- A partir de/vanaf 100 CV/PK

NEW
ECO-BX42S

- Maxi 8 cm - 192 kg
- Ejection vers le haut
Boven uitworp

PUGIO 5.5

- Maxi 4/5 cm
- Moteur Honda GX200
Honda motor GX200
- 1 lames - 6 fléaux
1 mes - 6 hammers

SCUTUM 9.0

- Maxi 7/8 cm
- Moteur Honda GX390
Honda motor GX390
- OU / OF**
3-points tracteurs
3-punt tractoren
- 2 lames - 6 fléaux
2 messen - 6 hammers



**PRESSES À PELLETS
PELLETS MACHINES**

REF	ENTRAÎNEMENT AANDRIJVING	KG	DIMENSIONS AFMETINGEN
PTE50	4KW-5,5CV/PK 380V	105 kg	900x500x1050 mm
PTE50M	KOHLER 7CV/PK	108 kg	900x500x1080 mm
PTT50	TRACTEURS TREKKERS 15-30CV/PK	102 kg	650x750x1200 mm



OPTION :

Silo / Doseur à vis

OPTIE :

Doseerbak met vijs



**TAPIS CONVOYEURS
TRANSPORTBAND**

- 5/6/7/8 m
- **Entraînement :** hydraulique tracteur ou moteur électrique (220 ou 380v)
- **Aandrijving :** hydraulische van trekker of elektrische motor (220 of 380v)



**FAGOTTEUSES
HOUTBUNDELAPPARATEN**



**FENDEUSES SUR REMORQUE
HOUTKLIEVERS OP AANHANGWAGEN**

REF	 Kg.	PUISSANCE KRACHT	DEGAGEMENT MAXI KLIEFHOOGTE
F12TH	255	12T-6CV/PK	0,55 m
VMR12	450	12T-9CV/PK	1,08 m
F14TH	425	14T-6CV/PK	1,05 m
VMR16	490	16T-9CV/PK	1,08 m
VMR16	490	16T-13CV/PK	1,08 m
F18TH	485	18T-7CV/PK	1,05 m



**SCIES CIRCULAIRES
ZAAGTAFELS**

XYLOSCIE 600T Ø 600

XYLOSCIE 700T Ø 700



**FENDEUSES DE BÛCHES
HOUTKLIEVERS**



ECO

- 13/14/16 T
- 0,72 m - 1m08
- 2 vitesses / 2 snelheden
- Verin escamotable
Opvouwbare vizel

FARMER II

- 14/15/17/20/23 T
- 0,72 m - 1m15
- 2 vitesses
2 snelheden



- Electrique / Elektrische 220/380 v
- Cardan / Aftakas
- Lame Widia / Widia blad
- Moteur essence / Benzine motor

- OPTION :** tapis convoyeur
- OPTIE :** transportband

FENDEUSES DE BÛCHES HOUTKLIEVERS

TRACTEURS - TREKKERS

MX 112

12 T - 1m10

MX 114

14 T - 1m10

- 2 vitesses
- Pompe + cardan
- Verin escamotable
- Table pour petites bûches
- 2 snelheden
- Pomp + aftakas
- Opvouwbare vijzel
- Tafel voor kleine blokken



MX 112
MX 114

MXK 114

14 T - 1m13

MXK 116

16 T - 1m22

NEW



MXK 114
MXK 116



MX 120

Coin étoile 4 tranchants
Kruiswige kliefmes



MX 121

21 T - 1m22

- 2 vitesses
- Pompe + cardan
- Verin escamotable
- Table pour petites bûches

- 2 snelheden
- Pomp + aftakas
- Opvouwbare vijzel
- Tafel voor kleine blokken



MX 121

MX 130

30 T - 1m10

- Supervelox
- Pompe + cardan
- Verin escamotable
- Table pour petites bûches

- Supervelox
- Pomp + aftakas
- Opvouwbare vijzel
- Tafel voor kleine blokken

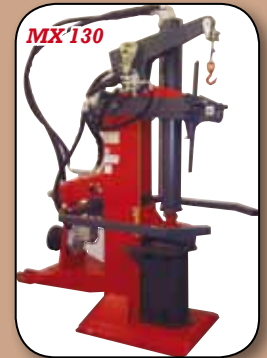

MX 130

MX 220

20 T - 1m22

- Supervelox
- Coin étoile 4 tranchants
- Horizontal

- Supervelox
- Kruiswige kliefmes
- Horizontaal



MX 220

MX 511 MULTI

11 T - 0,60m

Verticale / Horizontale



OPTIONS : treuil hydraulique

OPTIES : hydraulische lier



**EGALEMENT DISPONIBLE AVEC
MOTEUR ELECTRIQUE ET ESSENCE**

**OOK LEVERBAAR MET ELEKTRISCHE
OF BENZINE MOTOR**

SCIES CIRCULAIRES ZAAGTAFELS

- Ø 700 Widia
- Entraînement par cardan ou moteur électrique (220 ou 380 V)
- Ø 700 Widia
- Aandrijving : aftakas of elektrische motor (220 of 380 V)



OPTIONS OPTIES

- Tapis tournant
- Verstelbare transportband

AUSSI / OOK

- Avec tapis 4 ou 5 m
- Met afvoerband van 4 of 5 m



EQUIPEMENTS NEIGE

SNEEUWMACHINES

**LAMES À NEIGE
SNEEUWSCHUIVEN**

ECO

- 1m30 - 1m40 - 1m50 - 1m80
- Pour micro-tracteurs
- Pour chargeurs
- 3-points
- 1m30 - 1m40 - 1m50 - 1m80
- Voor micro-trekkers
- Voor frontladers
- 3-punt



LSE 130



- 1m30 - Hauteur 43 cm
- Pour micro-tracteurs de 12 à 25 CV

OPTION :
Relevage + orientation hydraulique

- 1m30 - 43 cm hoogte
- Voor micro-trekkers tussen 12 en 25 PK

OPTIE :
Hydraulische opheffing en orientatie

PRO LS

- 1m20 - 1m50 - 2m
- Pour tracteurs de 17 à 40 CV

OPTION :
Relevage + orientation hydraulique

- 1m20 - 1m50 - 2m
- Voor trekkers tussen 17 en 40 PK

OPTIE :
Hydraulische opheffing en orientatie



FOURCHES À PALETTES / PALLETVORKEN

- 1m20 - 1m40 - 1m60 - 1m80 - 2m



**EPANDEURS DE SEL
ZOUTSTROOIERS**

3-POINTS / 3-PUNT

- 150 - 250 - 350 l



- Version pro avec roues débrayables
- Pro versie met uitschakelbare aandrijving

**CUVES ACIER
OU POLYÉTHYLÈNE
IJZER OF
POLYETHYLEEN VAT**



POUSSÉS / GEDUWDE

- 301 - 401 - 501

CABINES

POUR / VOOR

Kubota

B20 - BX 2350 - B30 - L3200
L4100 - L40 - SERIE M - RTV

ISEKI TM - TH - TXG

TRACTEURS HORTICOLES / TUINBOUW TREKKERS :

Same - Landini - Lamborghini - Deutz - JD - Claas - Mac Cormick
Valpadana - New Holland - Ferrari - Goldoni - Pasquali - BCS - KIOTI - ...



Photos non contractuelles. Toutes les données techniques sont révisables et données à titre purement indicatif. Alle gegevens mogen veranderen. Neemt contact met ons voor meer inlichtingen.

ACCESSOIRES TRACTEURS

TOEBEHOREN VOOR TREKKERS

ATTELAGE ET PIÈCES DE RELEVAGE / HEF EN KOPPELDELEN



CONTREPOIDS 20 KG / FRONTGEWICHTEN VAN 20 KG

ATTACHE REMORQUES 3-POINTS / 3-PUNT TREKHAKEN



BOULES D'ATTELAGE / TREKHAKKOGELS

KIT RELEVAGE POUR KUBOTA ET ISEKI / HEFSET VOOR KUBOTA EN ISEKI



BOITIER INVERSEUR PTO / KEERKOPPELING PTO

ADAPTATEUR PTO - CARDAN / PTO VERLOOPSTUKKEN AFTAKAS



RELEVAGE FRONTAL / FRONTLIFT

EQUIPEMENT ÉLECTRIQUE / ELEKTRISCHE TOEBEHOREN



RAMPES DE CHARGEMENT / OPRIJBRUGGEN

- 2m - 3310 kg
- 2m50 - 2800 kg
- 3m23 - 1820 kg

DIVERS / DIVERSE



NEW

MINI-PELLES 1,3 À 3 T

MINIKRANEN 1,3 TOT 3 T

Sentar
by Univert

REF	T	TYPE MOTEUR MOTOR TYPE	CV / PK
M13	1350 kg	D902	19
M16	1530 kg	D902	19
M18	1740 kg	D902	19
M22	2100 kg	D1105	23,7
M28	2680 kg	D1703M	30
M35	3070 kg	D1703	32

- Moteur *Kubota*
- Canopy ou cabine
- Sortie hydraulique auxiliaire
- *Kubota* motor
- Canopy of cabine
- Extra hydraulische lijn



Cabine



M16



M13



M18



M22



M28



M35

TRACTEURS HORTICOLES TUINBOUWTRACTOREN

DONG FENG

Plus d'informations - Meer inlichtingen
Aussi liste des dealers - Ook dealers lijst

WWW.DONGFENG.BE

DF254 25CV-PK / DF304 30CV-PK / DF404 40 CV-PK



- Diesel - 4x4
- Direction assistée - 8 AV + 8 AR
- 540/1000 TR/Min

OPTIONS :

Chargeur frontal
Cabine - Relevage frontal
Pneus gazon

- Diesel - 4WD
- Stuurbeheersing - 8V + 8A
- 540/1000 TPM

OPTIES :

Frontlader
Cabine-frontlift
Gazonbanden



HOMOLOGUÉS CE - IMMATRICULABLES

CE EN VERKEER GOEDGEKEURD

FIABLES - ROBUSTES - ECONOMIQUES / BETROUWBAAR - STERK - GOEDKOOP

Importateur pour la Belgique et le Grand-Duché de Luxembourg - Invoerder voor België en Luxemburg

Kubota

**TRACTEURS 12 à 135 CV
TRACTOREN 12 tot 135 PK**

**AUTOPORTÉES 14 à 36 CV
ZITMAAIERS 14 tot 36 PK**



**TOP QUALITÉ
TOP KWALITEIT**

Rue de la Gendarmerie, 48 - 5600 PHILIPPEVILLE

DURANT

AGRICOLE & JARDIN

071/66 74 92



Ouvert du lundi au vendredi de 8h30 à 12h30 et de 13h30 à 18h30.

Le samedi de 9h à 13h (17h en saison).

Open van 8u30 tot 12u30 en van 13u30 tot 18u30.

Zaterdag van 9u tot 13u (17u in seizoen)

www.sprldurant.be

sprldurant@sprldurant.be